

Installation and Maintenance Manual

MRPW-C

Performa™ Winch 40.2 PTP



HARKEN®

Introduction	3
Technical characteristics	3
<i>Weight</i>	3
<i>Maximum working load</i>	3
Outline	3
Installation	4
<i>Installation procedure</i>	5
Maintenance	7
<i>Washing</i>	7
<i>Maintenance table</i>	7
<i>Disassembly procedure</i>	8
<i>Exploded view with maintenance products</i>	11
<i>Assembly</i>	12
Harken® limited worldwide warranty	12
Ordering spare parts	12
Exploded view	14
Parts list	16

Introduction

This manual gives technical information on winch installation and maintenance, including disassembling and reassembling.

This information is DESTINED EXCLUSIVELY for specialised personnel or expert users.

Installation, disassembling and reassembling of the winch by personnel who are not experts may cause serious damage to users and those in the vicinity of the winch.

Harken® accepts no responsibility for defective installation or reassembly of its winches.

In case of doubt the Harken® Tech Service is at your disposal at techservice@harken.it

This Manual is available only in English. If you do not fully understand the English language, do not carry out the operations described in this Manual.

Technical characteristics

	Power ratio	Gear ratio
1st speed	13,50 : 1	2,13 : 1
2nd speed	39,90 : 1	6,28 : 1

The theoretical power ratio does not take friction into account.

Weights

	PT version
Weight (Kg)	3,5

Maximum working load



WARNING!

The maximum working load (MWL) for the 40.2 PT Performa™ Winch is 850 Kg (1874 lb). Subjecting the winch to loads above the maximum working load can cause the winch to fail or pull off the deck suddenly and unexpectedly during high loads causing severe injury or death.

Outline

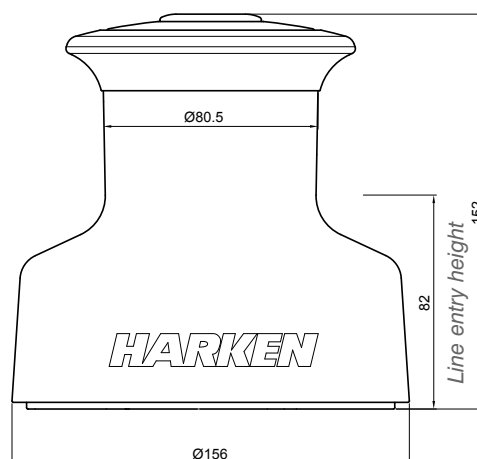

Installation

The winch must be installed on a flat area of the deck, reinforced if necessary to bear a load equal to at least twice the maximum working load of the winch.

It is the installer's responsibility to carry out all structural tests needed to ensure that the deck can bear the load.

Harken® does not supply the screws needed to install the winch since these may vary depending on the deck on which it is to be installed. It is the installer's responsibility to choose the correct screws taking account of the loads they will have to bear. Harken® assumes no responsibility for incorrect installation of its winches or for an incorrect choice of mounting screws.



DANGER!

Incorrect installation of the winch may cause severe injury or death. Consult the yard that built the boat in the case of doubt over the correct positioning of the winch.



WARNING!

Failure to use the correct number and type of mounting fasteners or failure to ensure the correct deck strength can result in the winch pulling off the deck suddenly and unexpectedly during high loads causing severe injury or death.



WARNING!

Verify the entry angle of the sheet. This must be 8° with tolerance of $\pm 2^\circ$, to avoid sheet overrides and damaging the winch or making the winch inoperable leading to loss of control of the boat which can lead to severe injury or death.

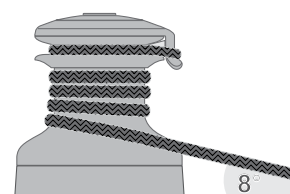

WARNING!

Mount the winch on the deck so that the drive gear is positioned where the sheet enters the winch drum. Incorrect position of drive gear can weaken winch leading to failure which can cause an accident leading to severe injury or death.

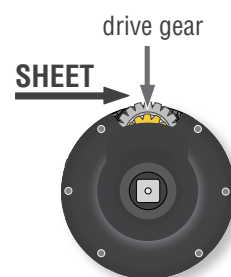

Once you have chosen the correct mounting position for the winch on the deck proceed with installation.

Procedure

To install the winch, remove the drum and use Socket Head (SH) bolts.

Tools needed

 One medium flat-bladed screwdriver

To identify the various parts, refer to the exploded view at the end of this Manual.

 Torque to apply when assembling



1. Unscrew the central screw (⚙️ 2Nm/18 in-lb)



2. Slide off the hub n°27 and the cover n°25 and the washer n°29



3. Lift off the drum n°21

Install the winch on the deck in the position you have chosen, keeping in mind the limits described on page 3.

Installation procedure

Carry out the **Procedure**, then install the winch on the deck in the chosen position.

- A.** Position the base of the winch on the deck and mark the position of the holes or use the drilling cut-out template at the point where you have decided to place the winch.

Below is a reduced scale diagram.

The drilling cut out template is available on the Harken® website, www.harken.com

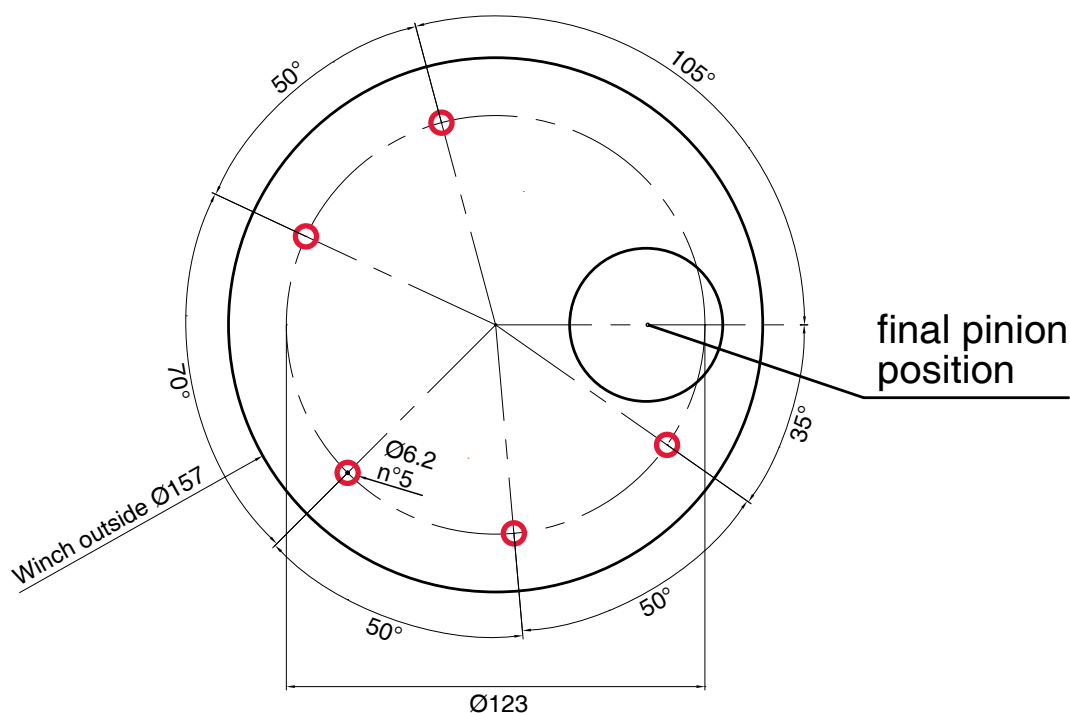

- B.** Remove the winch and drill the five 6.2 mm diameter holes.

- C.** Bolt the base of the winch to the deck using five M6 bolts (not supplied by Harken®), correctly chosen for the thickness and type of the boat deck. Consult the yard that built the boat in case of doubt.



WARNING!

To install the winch on the deck, use only bolts in A4 stainless steel (DIN 267 part11). Bolts made of other materials may not have sufficient strength or may corrode which can result in winch pulling off deck suddenly and unexpectedly during high loads causing severe injury or death.

NOTICE

To mount winches on the deck, do not use countersunk bolts.

- D.** Fill the mounting holes with a suitable marine sealant.
- E.** Remove the excess adhesive/sealant from the holes and base drainage channels

F. Reassemble the winch following the steps of the **Procedure** in the reverse order, and apply the products indicated in the section on maintenance.

NOTICE

Before closing the winch, make sure the holes and drainage channels in the base of the winch are not obstructed.

Maintenance

Washing

Winches must be washed frequently with fresh water, and in any case after each use.

Do not allow teak cleaning products or other cleaners containing caustic solutions to come into contact with winches and especially anodised, chrome plated or plastic parts.

Do not use solvents, polishes or abrasive pastes on the logos, on the stickers on the winches or on any anodized, chrome plated and plastic surfaces.

Make sure that the holes and drainage channels in the base of the winch are not obstructed so that water does not collect.

Maintenance table

Winches must be visually inspected at the beginning and end of every season of sailing or racing.

In addition they must be completely overhauled, cleaned and lubricated at least every 12 months.

After an inspection, replace worn or damaged components. Do not replace or modify any part of the winch with a part that is not original.



**WARNING!**

Periodic maintenance must be carried out regularly. Lack of adequate maintenance shortens the life of the winch, can cause serious injury and also invalidate the winch warranty. Installation and maintenance of winches must be carried out exclusively by specialized personnel.

In the case of doubt contact Harken® Tech Service at techservice@harken.it

Disassembly procedure

Tools needed

-  One medium flat-bladed screwdriver
-  A number five hex key
-  Rags

To identify the various parts refer to the exploded view at the end of this Manual.

 Torque to be applied in assembly phase

Carry out procedure as shown in the paragraph on winch installation and then do the following:



4. Completely unscrew the three screws n° 24



5. Remove the socket support n°20



6. Slide out the central shaft n°18



7. Unscrew the 6 hex screws n°15
(\approx 8Nm/71 in-lb)

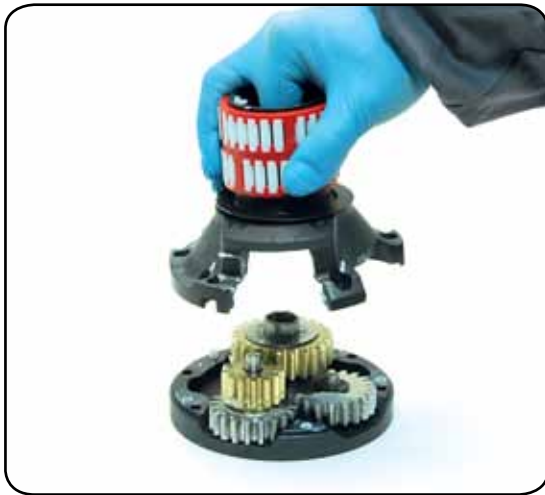

8. Remove the drum support n°14
Important: washer n°11 may remain
inside the drum support!

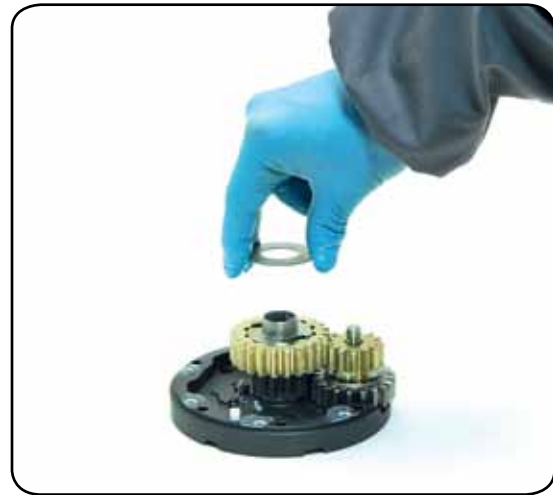

9. Remove the washer n°11



10. Remove the gearing n°6 and remove the
pawls n°4. To facilitate the operation press
the spring against the pawl with a blade.



11. Slide off gear n°2



12. Slide off gear n°13



13. Remove shaft n°7



14. Slide off gear n°9



15. Remove the pawls n°4. To facilitate the operation press the spring against the pawl with a blade.

Inspect balls inside the drum and carefully check the correct position; if it is necessary to put back any balls, push balls in the race (as shown below):



Once the winch is completely disassembled, clean the parts with a degreasing that does not leave residues, proper to clean metal components; rinse plastic parts in fresh water. Once you have done this, dry the parts with cloths that do not leave residue.

Inspect gears, bearings, pins and pawls for any signs of wear or corrosion.

Carefully check the teeth of gears and ring gears to make sure there are no traces of wear.

Check the roller bearings and check there are no breaks in the bearing cages.

Replace worn or damaged components.

Carry out maintenance on components using the products listed below.

For more information on which products to use where, refer to the exploded diagram below.

Use a brush to lightly lubricate all gears, gear pins, teeth and all moving parts with grease.

Lightly lubricate the pawls and springs with oil. Do not use grease on the pawls!

Exploded view with maintenance products

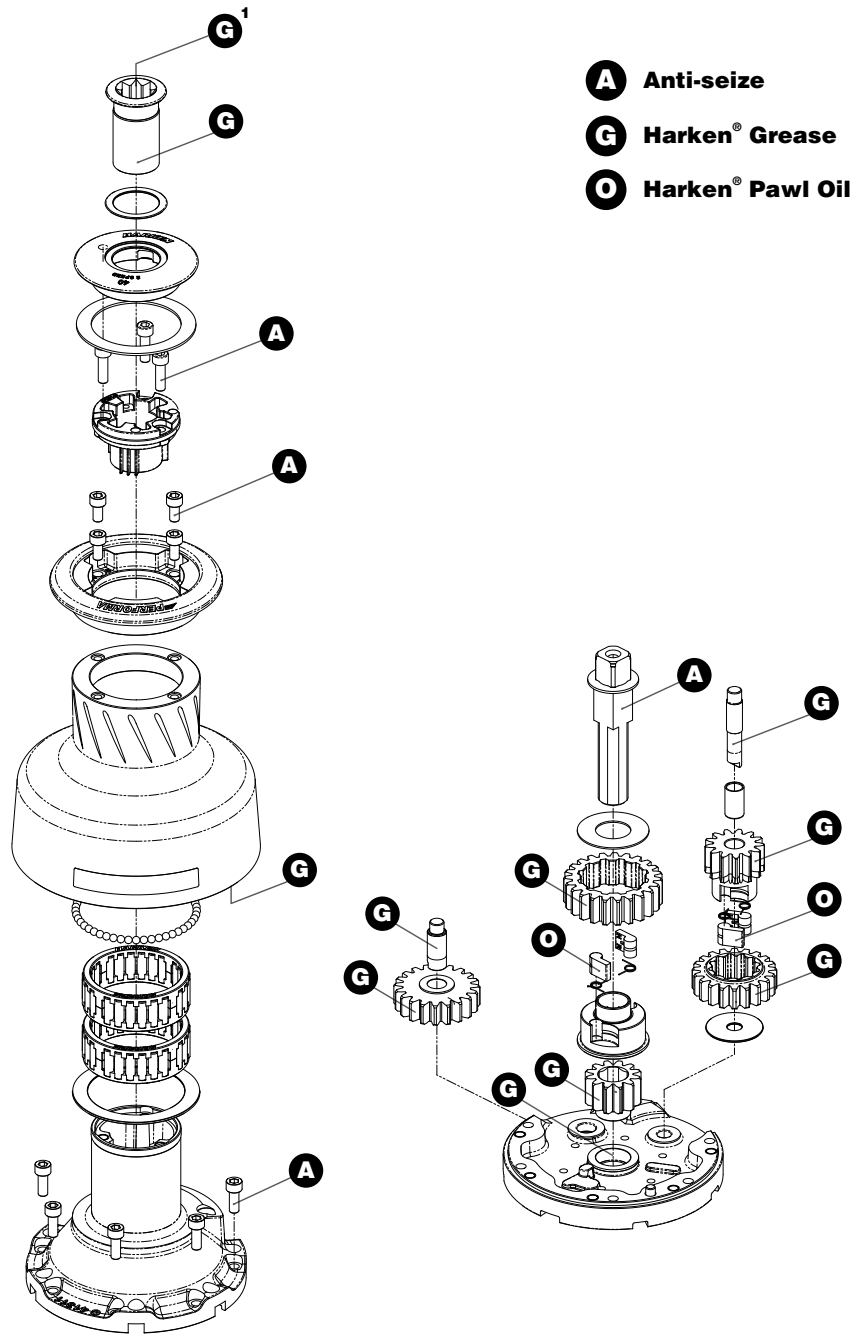

Apply Harken® grease where indicated above
 Apply Harken® grease: 1. on assy socket screw

NOTICE

On every gear and every component that must be greased, apply Harken® grease with a brush in a proper quantity as shown below:



NOTICE

Harken® grease to apply on all teeth: do not use excessive quantity of product to void wastes. If in contact with the pawls, an excess of grease can compromise the safety of the winch.

Assembly

Make sure that the holes and drainage channels in the base of the winch are not obstructed. Assemble the winch in the reverse order of the sequence in the section on disassembly.

To tighten bolts, use the torque indicated in the disassembly procedure.

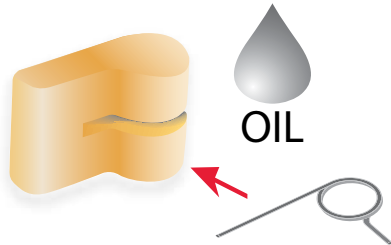

To assemble the pawls:

correctly position the spring in its housing as shown at left. Hold the spring closed and slide the pawl into its housing. Once in position, check that the pawls can be easily opened and closed with a finger.

In case of doubt concerning the assembly procedure contact Harken® Tech Service: techservice@harken.it

Harken® limited worldwide warranty

Refer to the Harken® Limited Worldwide Warranty in the Harken® Catalogue and on the website www.harken.com

Ordering spare parts

Spare parts can be requested from Harken® as described in the Harken® Limited Worldwide Warranty, indicating the part number in the Parts List and including the serial number of the winch for which the parts are required.

The serial number of the winch is printed on a plate on the drum support of the winch.

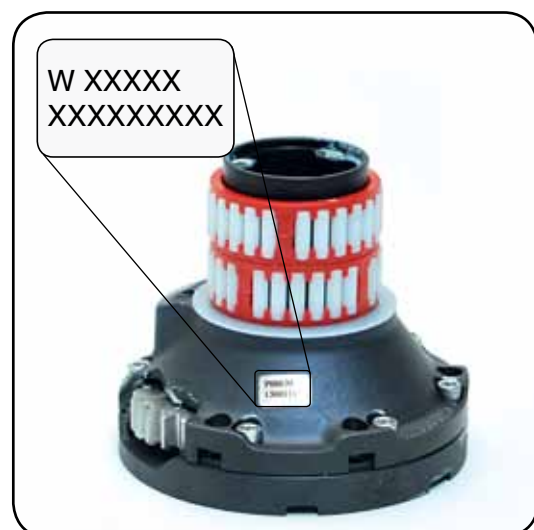

Manufacturer**Harken® Italy S.p.A.**

Via Marco Biagi, 14
22070 Limido Comasco (CO) Italy
Tel: (+39) 031.3523511
Fax: (+39) 031.3520031
Email: info@harken.it
Web: www.harken.com

- **Tech Service**
Email: techservice@harken.it
- **Customer Service**
Tel: (+39) 031.3523511
Email: info@harken.it

Headquarters**Harken®, Inc.**

1251 East Wisconsin Avenue
Pewaukee, Wisconsin 53072-3755 USA
Tel: (262) 691.3320
Fax: (262) 691.3008
Email: harken@harken.com
Web: www.harken.com

- **Tech Service**
Email: technicalservice@harken.com
- **Customer Service**
Tel: (262) 691-3320
Email: customerservice@harken.com

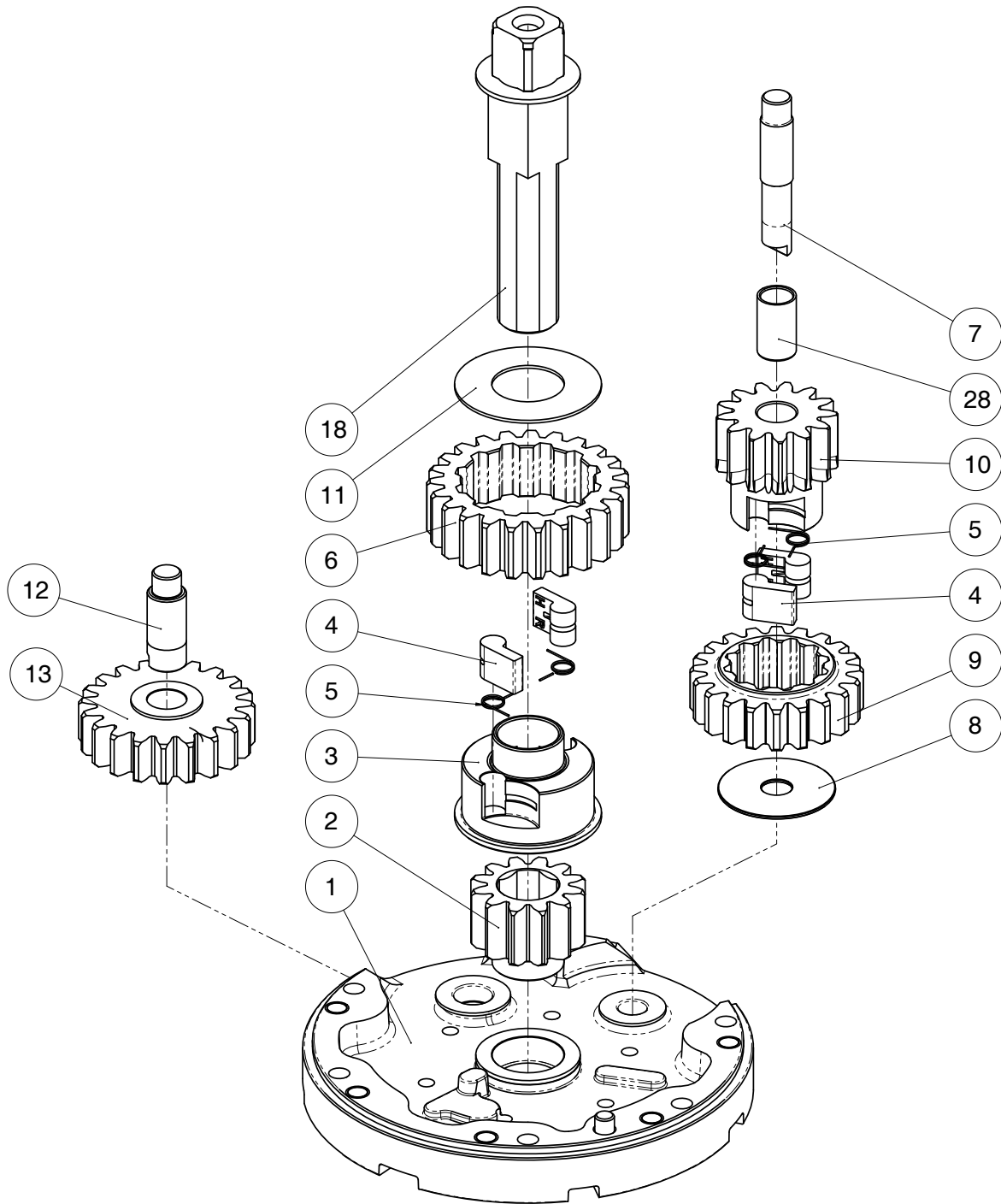

Radial Winch 40.2 PTP

Pos	Q.ty	Code	Description	Pos	Q.ty	Code	Description
1	1	A96633200	Performa Winch 40 Base Assy	18	1	A94151900	Assy Central Shaft W35
	1	S413350080	Performa Base W40		1	S413880002	Central shaft W35/40 PT Washer Ø17.2xØ32x1.5
	1	S4152300A7	Roller Ø6x19	19			Winch Serial Number Sticker
	1	S413960085	Bushing Ø22xØ25x9.5	20	1	S4151400A0	Socket Support PT
	1	S413330085	Bushing Ø9xØ11x12	21	1	A96572600	Performa Drum W40
2	1	S413020004	Bushing Ø12xØ14x11				Performa Drum W40
3	1	S413030004	Gear Z12				Performa Drum W40
4	4	S000090004	Pawls Carrier Ø8xN2		1	S6572700A3	Winch Product Sticker**
5	4	S000380001	Racing pawl Ø8*		49	M0619580	Bearing ring W40
6	1	S412830041	Pawl Spring Ø8*				Ball 3/16"
7	1	S657380004	Gear Z23	22	1	S657330153	Performa Plain Top W35/40
8	1	S279090002	Performa Pin Ø9x10 W40	23	4	M0603703	Screw M6x12 UNI 5931
9	1	S412970004	Washer Ø36xØ9,5x1	24	3	M0600903	Screw M6x20 UNI5931
10	1	S657370041	Gear Z20	25	1	S415540153	Cover W40 PT
11	1	S413120002	Performa Pinion Z13 W40	26	1	S415220080	PT spacer
12	1	S413070004	Washer Ø22.5xØ45x1	27	1	A94136400	Assembly Socket W20-80
13	1	A94130500	Pin Ø9xØ12x32.5		1	S415130085	Socket Handle W20/80
	2	S414900080	Assy Gear Z20		1	M0614303	Washer Ø7.7xØ25x5.8
			Gear Z20				Screw M8x20 UNI 6109
			Bushing Ø12xØ14x8	28	1	M6033794	Bushing XSM-1012-20
14	1	A94141500	Assy Housing Winch 40	29	1	S678720082	Washer Ø56.5xØ75x1.5
	2	S414890080	Support W40				
	1	S4130900A7	Bushing Ø9xØ11x7				
			Bushing Ø22xØ25x8.5				
15	6	M0635103	Socket head screw M6x16 UNI 5931				
16	1	S657280052	Performa Shim W40				
17	2	A74136000	Bearing Ø56xØ68x24				

*Available with service kit; see website www.harken.com

**Winch product sticker

