

Installation and Maintenance Manual

MRPW-D

Performa™ Winch 46.2 PTP



HARKEN®

Introduction	3
Technical characteristics	3
<i>Weight</i>	3
<i>Maximum working load</i>	3
Outline	3
Installation	4
<i>Installation procedure</i>	5
Maintenance	7
<i>Washing</i>	7
<i>Maintenance table</i>	7
<i>Disassembly procedure</i>	8
<i>Exploded view with maintenance products</i>	11
<i>Assembly</i>	12
Harken® limited worldwide warranty	12
Ordering spare parts	12
Exploded view	14
Parts list	16

Introduction

This manual gives technical information on winch installation and maintenance, including disassembling and reassembling.

This information is DESTINED EXCLUSIVELY for specialised personnel or expert users.

Installation, disassembling and reassembling of the winch by personnel who are not experts may cause serious damage to users and those in the vicinity of the winch.

Harken® accepts no responsibility for defective installation or reassembly of its winches.

In case of doubt the Harken® Tech Service is at your disposal at techservice@harken.it

This Manual is available only in English. If you do not fully understand the English language, do not carry out the operations described in this Manual.

Technical characteristics

	Power ratio	Gear ratio
1st speed	11,70 : 1	2,30 : 1
2nd speed	46,50 : 1	9,17 : 1

The theoretical power ratio does not take friction into account.

Weights

	PT version
Weight (Kg)	5,1

Maximum working load



WARNING!

The maximum working load (MWL) for the 46.2 PT Performa™ Winch is 1300 Kg (2866 lb). Subjecting the winch to loads above the maximum working load can cause the winch to fail or pull off the deck suddenly and unexpectedly during high loads causing severe injury or death.

Outline

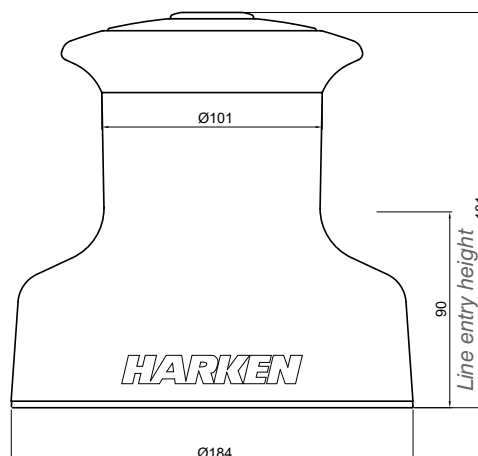

Installation

The winch must be installed on a flat area of the deck, reinforced if necessary to bear a load equal to at least twice the maximum working load of the winch.

It is the installer's responsibility to carry out all structural tests needed to ensure that the deck can bear the load.

Harken® does not supply the screws needed to install the winch since these may vary depending on the deck on which it is to be installed. It is the installer's responsibility to choose the correct screws taking account of the loads they will have to bear. Harken® assumes no responsibility for incorrect installation of its winches or for an incorrect choice of mounting screws.



DANGER!

Incorrect installation of the winch may cause severe injury or death. Consult the yard that built the boat in the case of doubt over the correct positioning of the winch.



WARNING!

Failure to use the correct number and type of mounting fasteners or failure to ensure the correct deck strength can result in the winch pulling off the deck suddenly and unexpectedly during high loads causing severe injury or death.



WARNING!

Verify the entry angle of the sheet. This must be 8° with tolerance of $\pm 2^\circ$, to avoid sheet overrides and damaging the winch or making the winch inoperable leading to loss of control of the boat which can lead to severe injury or death.

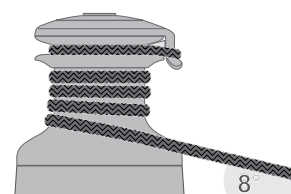

WARNING!

Mount the winch on the deck so that the drive gear is positioned where the sheet enters the winch drum. Incorrect position of drive gear can weaken winch leading to failure which can cause an accident leading to severe injury or death.

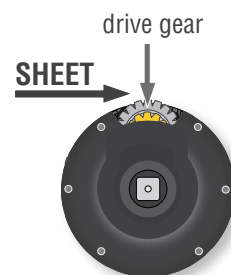

Once you have chosen the correct mounting position for the winch on the deck proceed with installation.

Procedure

To install the winch, remove the drum and use Socket Head (SH) bolts.

Tools needed

 One medium flat-bladed screwdriver

To identify the various parts, refer to the exploded view at the end of this Manual.

 Torque to apply when assembling



1. Unscrew the central screw (⚙️ 2Nm/18 in-lb)



2. Slide off the hub n°27 and the cover n°26 and the washer n°30



3. Lift off the drum n°22

Install the winch on the deck in the position you have chosen, keeping in mind the limits described on page 3.

Installation procedure

Carry out the **Procedure**, then install the winch on the deck in the chosen position.

- A.** Position the base of the winch on the deck and mark the position of the holes or use the drilling cut-out template at the point where you have decided to place the winch.

Below is a reduced scale diagram.

The drilling cut out template is available on the Harken® website, www.harken.com

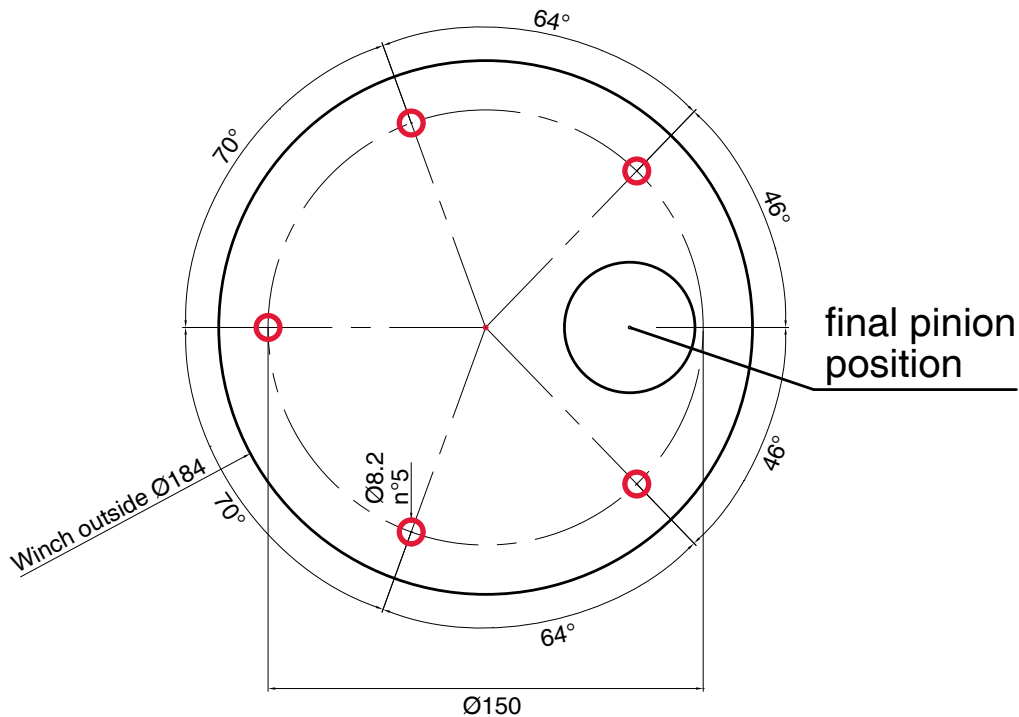

- B.** Remove the winch and drill the five 8.2 mm diameter holes.
- C.** Bolt the base of the winch to the deck using five M8 bolts (not supplied by Harken®), correctly chosen for the thickness and type of the boat deck. Consult the yard that built the boat in case of doubt.



WARNING!

To install the winch on the deck, use only bolts in A4 stainless steel (DIN 267 part11). Bolts made of other materials may not have sufficient strength or may corrode which can result in winch pulling off deck suddenly and unexpectedly during high loads causing severe injury or death.

NOTICE

To mount winches on the deck, do not use countersunk bolts.

- D.** Fill the mounting holes with a suitable marine sealant.
- E.** Remove the excess adhesive/sealant from the holes and base drainage channels

F. Reassemble the winch following the steps of the **Procedure** in the reverse order, and apply the products indicated in the section on maintenance.

NOTICE

Before closing the winch, make sure the holes and drainage channels in the base of the winch are not obstructed.

Maintenance

Washing

Winches must be washed frequently with fresh water, and in any case after each use.

Do not allow teak cleaning products or other cleaners containing caustic solutions to come into contact with winches and especially anodised, chrome plated or plastic parts.

Do not use solvents, polishes or abrasive pastes on the logos, on the stickers on the winches or on any anodized, chrome plated and plastic surfaces.

Make sure that the holes and drainage channels in the base of the winch are not obstructed so that water does not collect.

Maintenance table

Winches must be visually inspected at the beginning and end of every season of sailing or racing.

In addition they must be completely overhauled, cleaned and lubricated at least every 12 months.

After an inspection, replace worn or damaged components. Do not replace or modify any part of the winch with a part that is not original.



**WARNING!**

Periodic maintenance must be carried out regularly. Lack of adequate maintenance shortens the life of the winch, can cause serious injury and also invalidate the winch warranty. Installation and maintenance of winches must be carried out exclusively by specialized personnel.

In the case of doubt contact Harken® Tech Service at techservice@harken.it

Disassembly procedure

Tools needed

-  One medium flat-bladed screwdriver
-  A number five hex key
-  Rags

To identify the various parts refer to the exploded view at the end of this Manual.

 Torque to be applied in assembly phase

Carry out procedure as shown in the paragraph on winch installation and then do the following:



4. Completely unscrew the three screws n° 25 and remove the socket support



5. Slide out the central shaft n° 19



6. Unscrew the 5 hex screws n° 16
( 20Nm/177 in-lb)



7. Remove the assy housing n° 15.
Important: washer n° 12 may remain inside the drum support and the washer n° 29 must be replaced in the correct position.



8. Remove the gear n°14

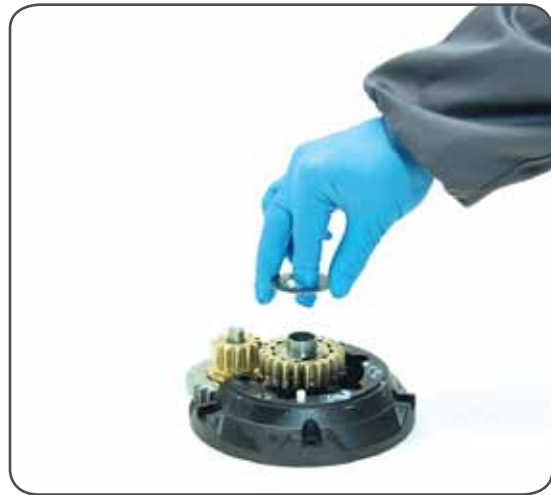

9. Remove the washer n°12



10. Remove the gearing n°9 and remove the pawls n°7. To facilitate the operation press the spring against the pawl with a blade.



11. Slide off gear n°2



12. Remove the pinion n°10.



13. Slide off gear n°5



14. Remove the washer n°4.

Inspect balls inside the drum and carefully check the correct position; if it is necessary to put back any balls, push balls in the race (as shown below):



Once the winch is completely disassembled, clean the parts with a degreasing that does not leave residues, proper to clean metal components; rinse plastic parts in fresh water. Once you have done this, dry the parts with cloths that do not leave residue.

Inspect gears, bearings, pins and pawls for any signs of wear or corrosion.

Carefully check the teeth of gears and ring gears to make sure there are no traces of wear.

Check the roller bearings and check there are no breaks in the bearing cages.

Replace worn or damaged components.

Carry out maintenance on components using the products listed below.

For more information on which products to use where, refer to the exploded diagram below.

Use a brush to lightly lubricate all gears, gear pins, teeth and all moving parts with grease.

Lightly lubricate the pawls and springs with oil. Do not use grease on the pawls!

Exploded view with maintenance products

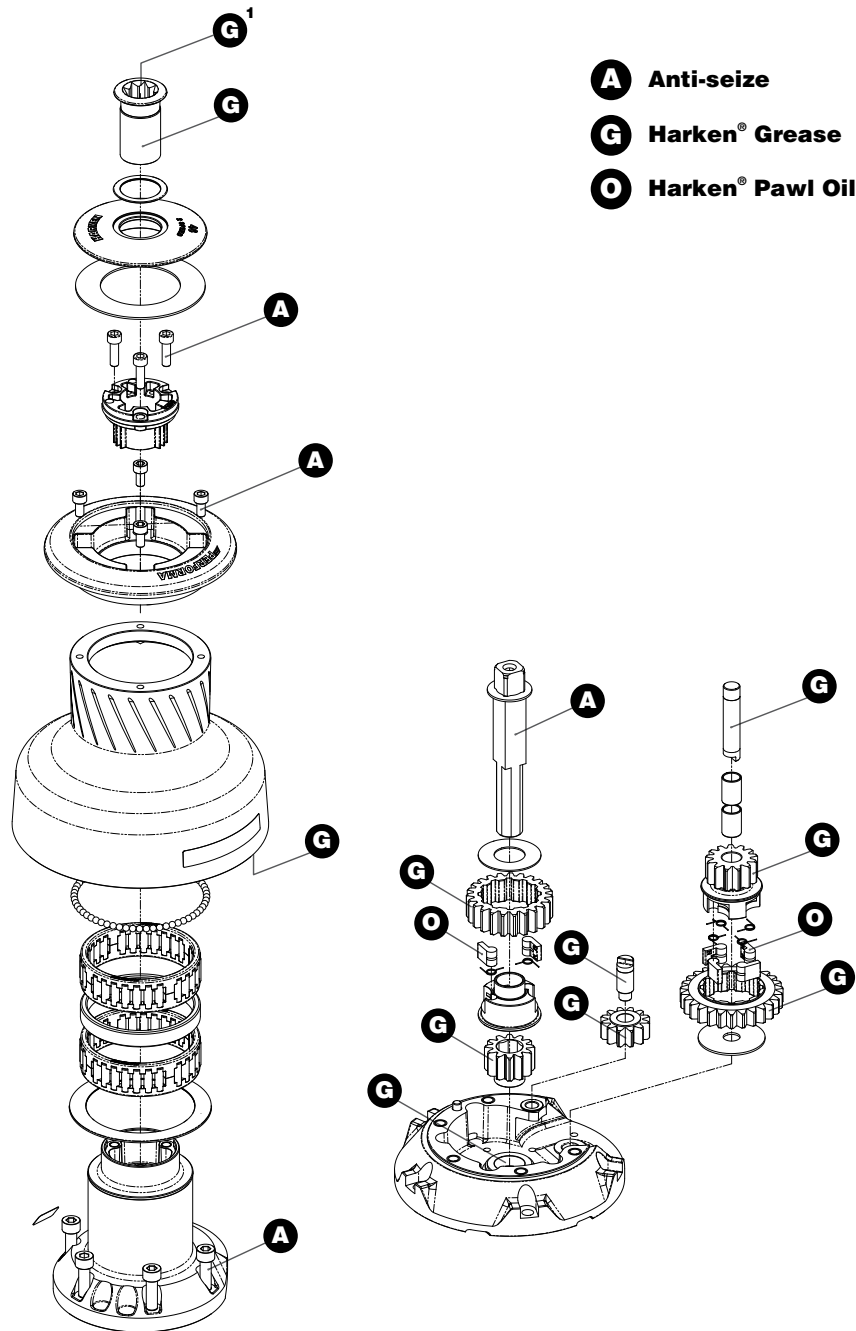

- A** Anti-seize
- G** Harken® Grease
- O** Harken® Pawl Oil

Apply Harken® grease where indicated above
 Apply Harken® grease: 1. on assy socket screw

NOTICE

On every gear and every component that must be greased, apply Harken® grease with a brush in a proper quantity as shown below:



NOTICE

Harken® grease to apply on all teeth: do not use excessive quantity of product to void wastes. If in contact with the pawls, an excess of grease can compromise the safety of the winch.

Assembly

Make sure that the holes and drainage channels in the base of the winch are not obstructed. Assemble the winch in the reverse order of the sequence in the section on disassembly.

To tighten bolts, use the torque indicated in the disassembly procedure.

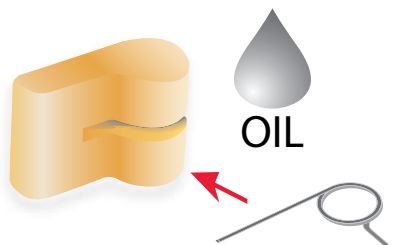

To assemble the pawls:

correctly position the spring in its housing as shown at left. Hold the spring closed and slide the pawl into its housing. Once in position, check that the pawls can be easily opened and closed with a finger.

In case of doubt concerning the assembly procedure contact Harken® Tech Service: techservice@harken.it

Harken® limited worldwide warranty

Refer to the Harken® Limited Worldwide Warranty in the Harken® Catalogue and on the website www.harken.com

Ordering spare parts

Spare parts can be requested from Harken® as described in the Harken® Limited Worldwide Warranty, indicating the part number in the Parts List and including the serial number of the winch for which the parts are required.

The serial number of the winch is printed on a plate on the drum support of the winch.



Manufacturer***Harken® Italy S.p.A.***

Via Marco Biagi, 14
22070 Limido Comasco (CO) Italy
Tel: **(+39) 031.3523511**
Fax: **(+39) 031.3520031**
Email: **info@harken.it**
Web: **www.harken.com**

- **Tech Service**
Email: **techservice@harken.it**

- **Customer Service**
Tel: **(+39) 031.3523511**
Email: **info@harken.it**

Headquarters***Harken®, Inc.***

1251 East Wisconsin Avenue
Pewaukee, Wisconsin 53072-3755 USA
Tel: **(262) 691.3320**
Fax: **(262) 691.3008**
Email: **harken@harken.com**
Web: **www.harken.com**

- **Tech Service**
Email: **technicalservice@harken.com**

- **Customer Service**
Tel: **(262) 691-3320**
Email: **customerservice@harken.com**

Exploded view 1/2

Radial Winch 46.2 PTP

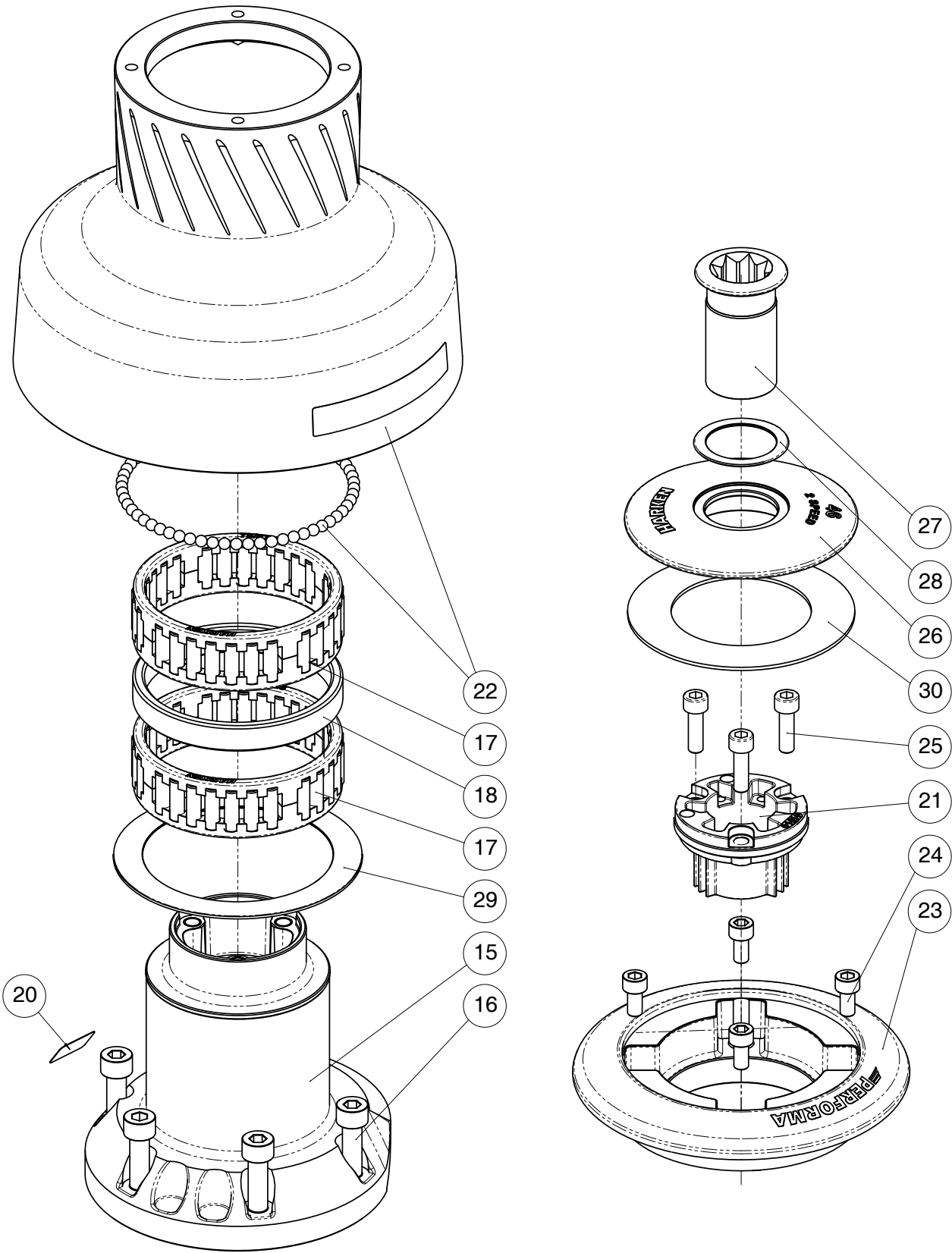

Radial Winch 46.2 PTP

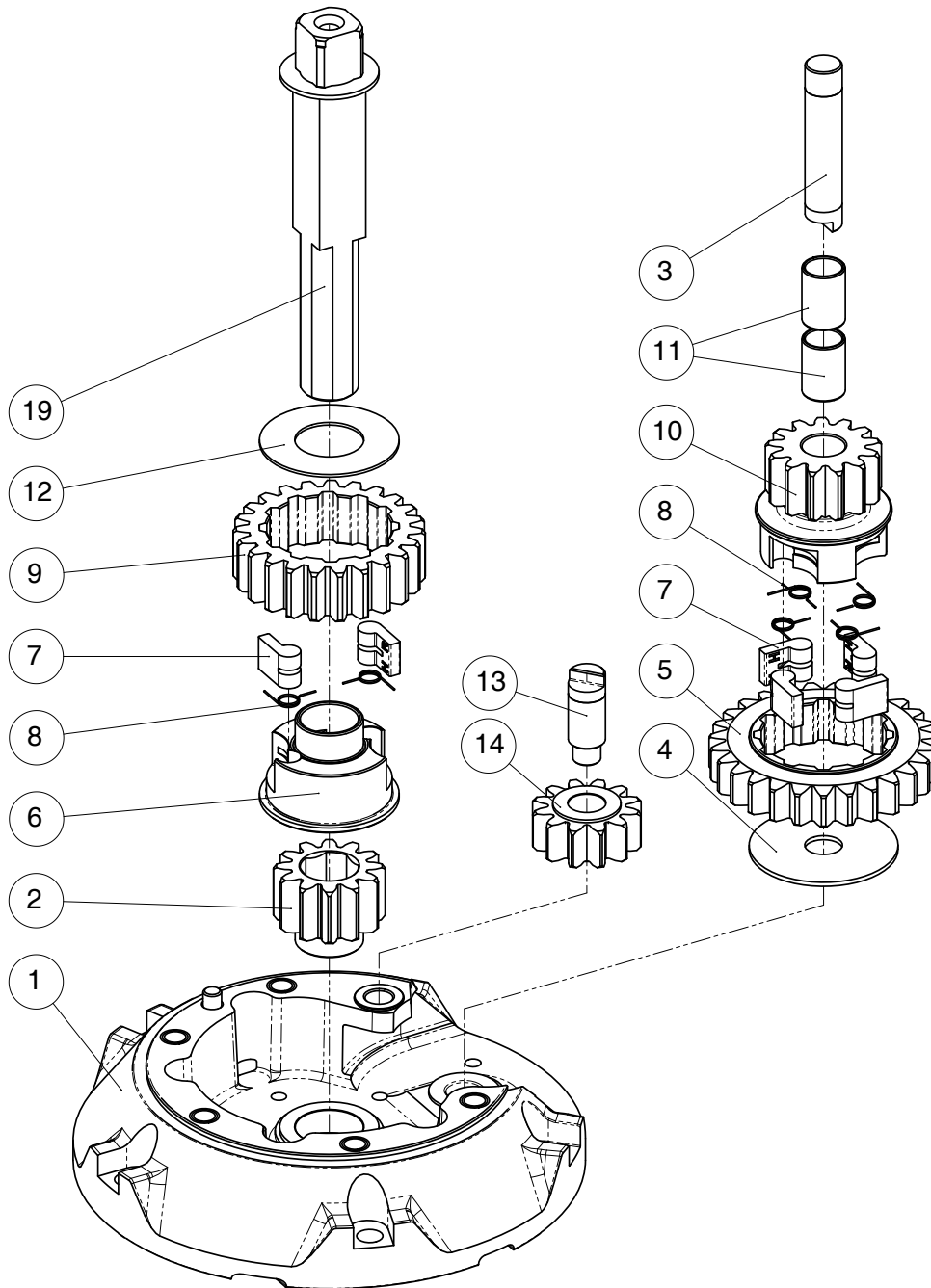

Radial Winch 46.2 PTP

Pos	Q.ty	Code	Description	Pos	Q.ty	Code	Description
1	1	A96633300	Performa assy base Winch 46	18	1	S413390080	Spacer
	1	S413350080	Performa base W46	19	1	A94189400	Assy Central Shaft Winch 46
	1	S4152300A7	Roller Ø6x19		1	S413880002	Central shaft W46 PT
	1	S414890080	Bushing Ø22xØ25x9.5				Washer Ø17.2xØ32x1.5
	1	S413330085	Bushing Ø9xØ11x7	20	1	S418760063	Winch Serial Number Sticker
	1	S413330085	Bushing Ø12xØ14x11	21	1	S4151400A0	Socket Support PT
2	1	S413020004	Gear Z12	22	1	A96572300	Performa W46 Drum
3	1	S413300004	Pin Ø12x60		61	M0619580	Performa Drum W46
4	1	S278170002	Washer Ø12.5xØ48x1.5				Ball 3/16"
5	1	S413260004	Gear Z27				Bearing ring W46
6	1	S414260004	Pawls Carrier Ø8xN2				Winch Product Sticker**
7	6	S000090004	Racing pawl Ø8*	23	1	S657340153	Performa Plain Top W46
8	6	S000380001	Pawl Spring Ø8*	24	4	M0603703	Screw M6x12 UNI 5931
9	1	S412830041	Gear Z23	25	3	M0600903	Screw M6x20 UNI5931
10	1	S413250041	Pinion Z13	26	1	S416190153	Cover W46 PT
11	2	M6017694	IGUS Bushing PSM-1214-20	27	1	A94136400	Assembly Socket W20-80
12	1	S413120002	Washer Ø22.5xØ45x1		1	S415130085	Socket Handle W20/80
13	1	S413070004	Pin Ø9xØ12x32.5		1	M0614303	Washer Ø7.7xØ25x5.8
14	1	A94133400	Assy Gear Z12				Screw M8x20 UNI 6109
	2	S414900080	Gear Z12	28	1	S415220080	PT spacer
			Bushing Ø12xØ14x8	29	1	S657300052	Performa Shim W46
15	1	A94132200	Assy Housing Winch 46	30	1	S678730082	Washer Ø57.5xØ93x1.5
	1	S414900080	Housing Winch 46				
	1	S413330085	Bushing Ø12xØ14x8				
	1	S4133200B3	Bushing Ø12xØ14x11				
	1	S4133200B3	Bushing for support				
16	5	M0606303	Screw M8x25 UNI 5931				
17	2	A74133700	Bearing Ø75xØ87x26				

*Available with service kit; see website www.harken.com

**Winch product sticker

